

T-Piece

with beaded, round and unperforated side profiles, but with connector perforations

WSTR 105.200

EAN Code: 4013339949885
 Smallest packaging unit: 1 pc.

the photorealistic images are to be considered as reference images

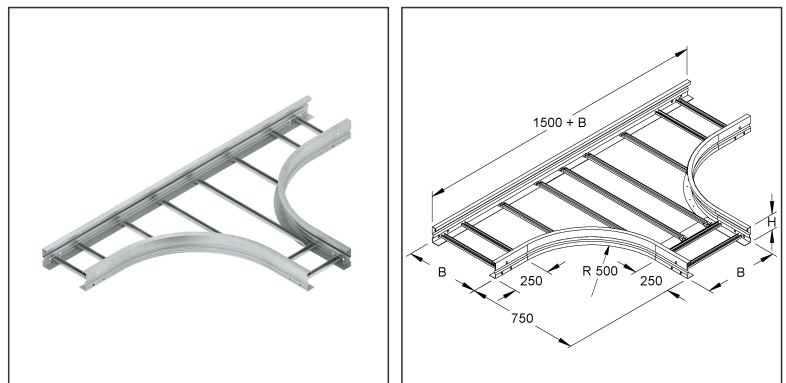

Article Description

T-piece for WSL, 105x200 mm, round, beaded, unperforated, steel, pre-galvanised according to DIN EN 10346

Additional Price Information

Article group	N13
quantity unit	pcs.

Weight

Weight per quantity unit	13 kg / pcs.
Weight in kg per 100	1324 kg / 100pcs.

Technical Datasheet

Long Span Cable Ladder

WSTR 105.200

the photorealistic images are to be considered as reference images

Physical Article Dimensions

Height	105.00 mm
Width	950 mm
Depth/length	1700 mm

Packing Dimension

1 piece = 1 piece		✓ VP1-smallest packaging unit (PU)			
Lenght	1700 mm	Width	950 mm	Height	105.00 mm
Gross weight	13 kg	Volume	0,170 m ³		
Min. quantity	1.00 pcs.	Max. Quantity	1.00 pcs.		

Tender Text

T-piece, with beaded, round and unperforated side rails, with connector perforation for connection, dimensionally stable due to riveted C-profile rungs open at the top with 16 mm slot width, for wide span cable trays, for making 90° T-outlets. Please order splice plates WSV 105.390 separately.
 The fitting radii are designed so that the cables can be laid in accordance with DIN/VDE 0298 Part 3.
 Corresponding U-clamps: B... and BK...
 Butt joints must be supported in the immediate vicinity by an appropriate supporting structure.
 Used for : wide span cable ladder WSL 105...
 Dimensions (approx. dimensions)
 Height H x Width W : 105 x 200 mm
 Length in main direction : 1500 mm + W
 Length in outgoing direction : 750 mm + W
 Inside rail radius R : 500 mm
 Material : steel, pre-galvanised according to DIN EN 10346
 NIEDAX Model No. : WSTR 105.200
 EP Material_____ EP Wage_____
 Unit price/piece

Safety & Environment

REACH Date	05.11.2025
REACH Info	Conformable
RoHS Info	Conformable

Origin & International Trade

Country of origin	DE
Customs tariff number	73089059

Technical Datasheet

Long Span Cable Ladder

WSTR 105.200

the photorealistic images are to be considered as reference images

Related items

Cover

Model No.	Description
WDRS 20	Turning bolt with locknut acc. to DIN EN ISO 10511, for WSL/WRL, steel, pre-galvanised according to DIN EN 10346, incl. accessories
WTRDV 200	Cover for T-piece for WSL/WRL, width 204 mm, with turning bolt, steel, pre-galvanised according to DIN EN 10346

Connector

Model No.	Description
WSV 105.390	Splice plate, 106,5x390 mm, steel, pre-galvanised according to DIN EN 10346, incl. accessories